

[As a leading Solar New Energy Supplier from China, our prioritized goal is to keep developing and producing high quality and high efficiency product OEM ODM]

3S – Standard & Service & Solution

About Us

3S Group - Solar3s - Mainland China officed in Shanghai and Shijiazhuang, Sub-branched in Germany and Hungary. With great supplying and sourcing ability in solar energy from China, ranging solar panels, inverters, batteries , solar systems, Co-projects and a full set of solar energy services for both commercial and residential. We are providing professional, reliable and trustful solar products and solar solution. Whether you are new to solar entirely or are looking to develop upon existing setting up or business , welcome to contact us for further service.

Our Products



Solar Panel



Car Charger



Micro Inverter



Energy Storage Battery





Wind-Solar Hybrid System
(New Trends)

Micro Inverter

On-Grid Inverter GTB Series

(Equipped with mobile phone monitoring, free of MODEM external installation)

Product	Type	Parameter
	GTB-400	DC input: 22-50VDC AC output: 110/230VAC Output power: 400W Size: 20 * 18.5 * 4cm Net weight: 0.9KG Gross weight: 1.45KG Single unit packaging: 24.5 * 20 * 10cm Full box packaging: 51 * 33 * 23cm(14kg) Packaging quantity: 10 units
	GTB-600	DC input: 22-50VDC AC output: 110/230VAC Output power: 600W Size: 29 * 20 * 4cm Net weight: 1.7KG Gross weight: 2.3KG Single unit packaging: 34.5 * 24 * 10cm Full box package: 51*38*22.5cm(14KG) Packaging quantity: 5 units

GTB-800

DC input: 22-50VDC
AC output: 110/230VAC
Output power: 800W
Size: 31 * 20 * 4cm
Net weight: 1.8KG
Gross weight: 2.5KG
Single unit packaging: 34.5 * 24 * 10cm
Full box packaging: 51 * 38 * 22.5cm
(14KG)
Packaging quantity: 5 units

GTB-1600

DC input: 22-50VDC
AC output: 110/230VAC
Output power: 1400W
Size: 37 * 30 * 4cm
Net weight: 2.8KG
Gross weight: 3.9KG
Single unit packaging: 43 * 37.5 * 11.5cm
Full box packaging: 44*40*27cm 15.8KG
Packaging quantity: 4 units

GTB-1200

DC input: 22-50VDC

AC output: 110/230VAC

Output power: 1200W

Size: 37 * 30 * 4cm

Net weight: 2.75KG

Gross weight: 3.9KG

Single unit packaging: 43 * 37.5 * 11.5cm

**Full box packaging: 44 * 40 * 27cm
(15.8KG)**

Packaging quantity: 4 units

GTB-1400

DC input: 22-50VDC

AC output: 110/230VAC

Output power: 1400W

Size: 37 * 30 * 4cm

Net weight: 2.8KG

Gross weight: 3.9KG

Single unit packaging: 43 * 37.5 * 11.5cm

**Full box packaging: 44 * 40 * 27cm
(15.8KG)**

Packaging quantity: 4 units

Basic Structure



Mounting Holes

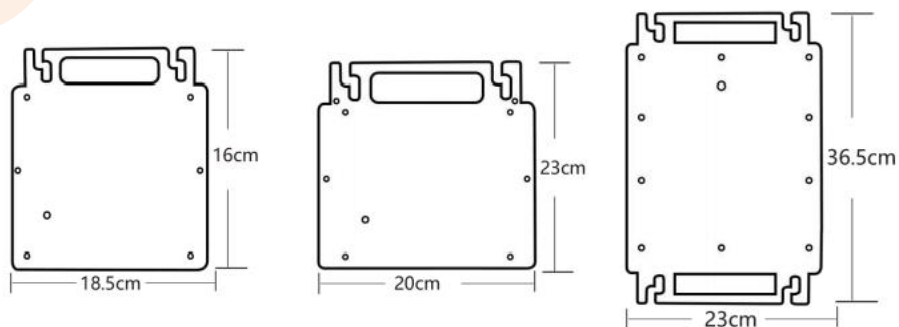
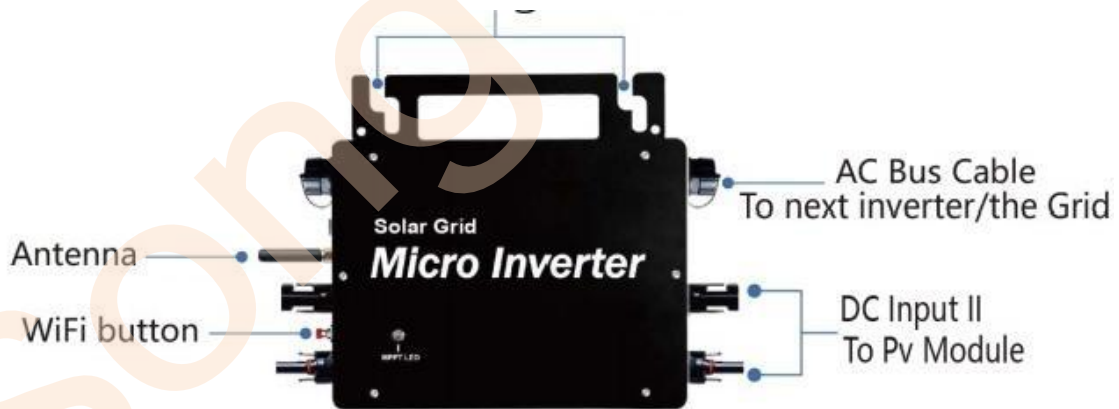

Connection Diagram



Only the solar panel is connected. When the mains AC is not connected, the red light on the inverter surface is on, and the instrument and machine do not work normally.

Normal working conditions of the inverter: the 22-50V DC voltage of the solar panel must be connected, and the AC voltage must be connected at the same time, and the indicator light is green.



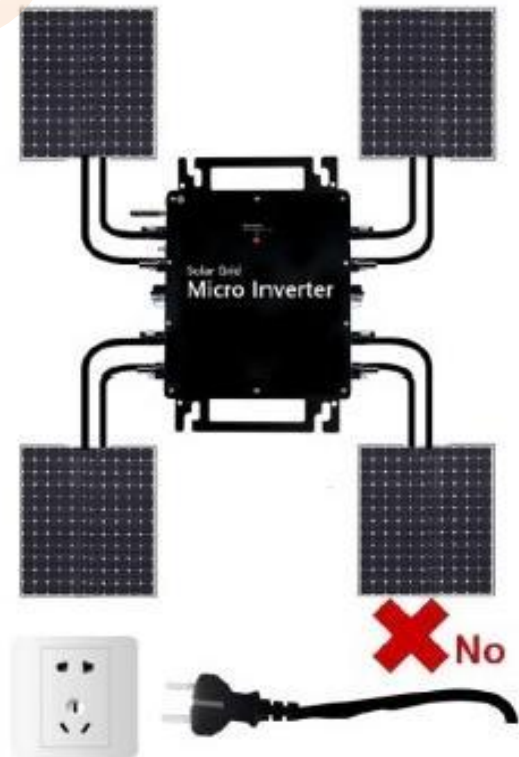
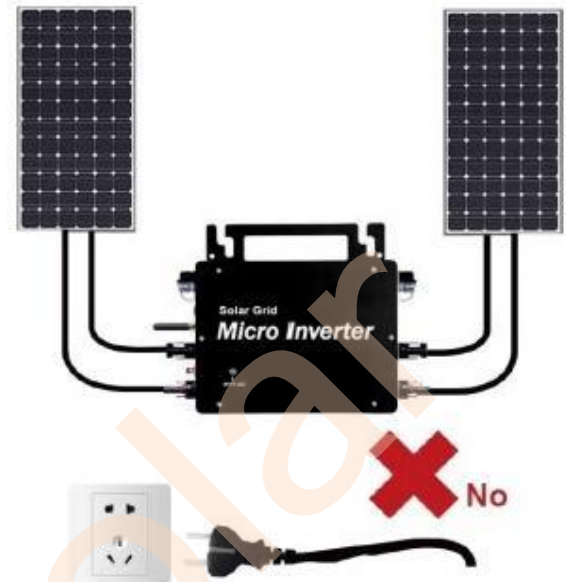
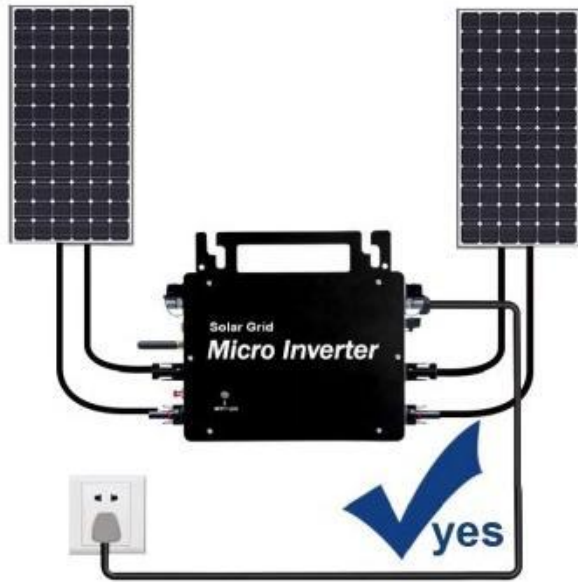

Application Scenario

Wiring

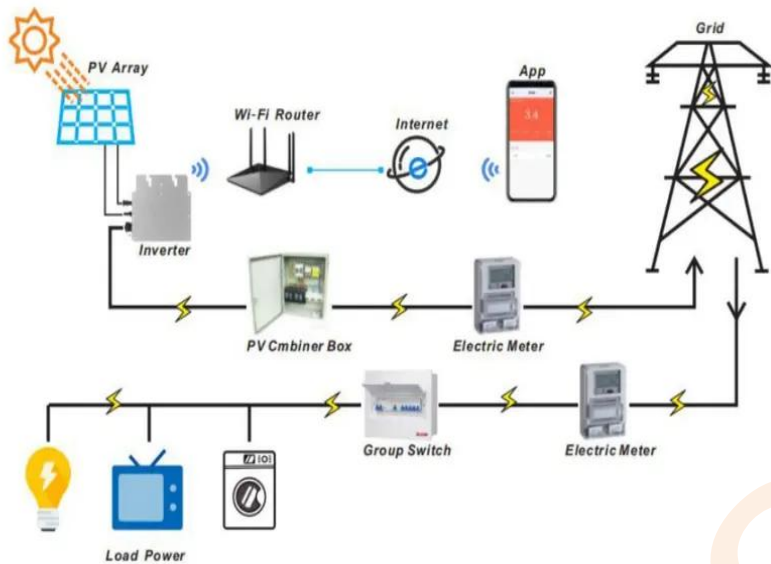

Wide Usage

It is suitable for various household appliances. It can convert the DC power generated by solar panels into AC power available for household appliances.



Address:

34th Floor, Evergrande Center, No. 77 Zhongshan West Road, Shijiazhuang China

0086-31168072747 info@solar3s.com

Building 5, No 59 Xibei, Luxiang, Jinshan, Shanghai, China

0086-13780077983 info@lin-joy.com

Kritenburg 17, 22319 Hamburg Germany

0049-17623329290 lijuncao@sysplendor.com

Budapest district 22 Hungary

36706661440 tibor@3shungary.com